

よくきいて ください。 \_\_\_\_\_ 月 \_\_\_\_\_ 日 \_\_\_\_\_ 曜日 名前 \_\_\_\_\_

☆. きこえた ことばのえに シールを はりましょう。

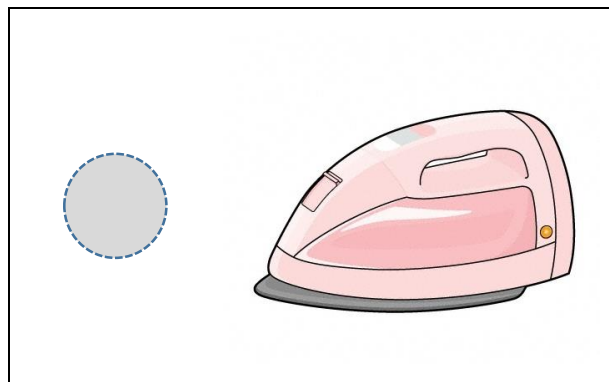
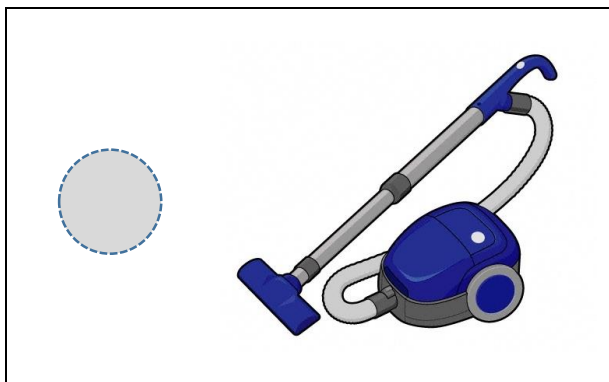
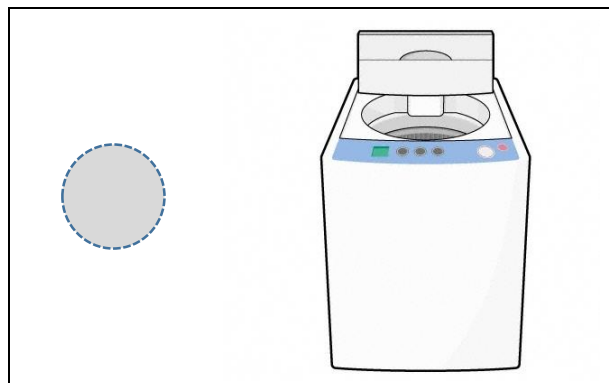
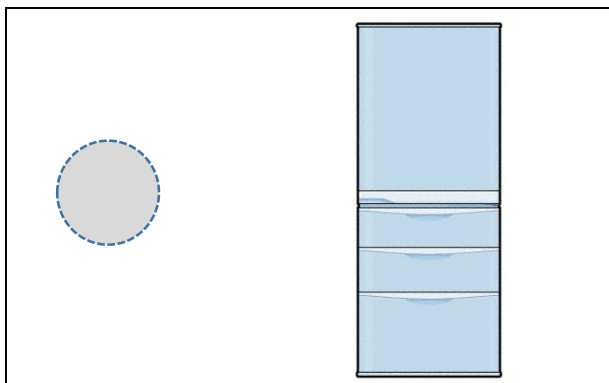
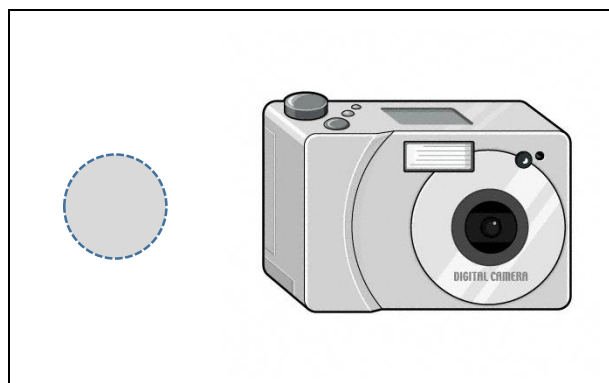
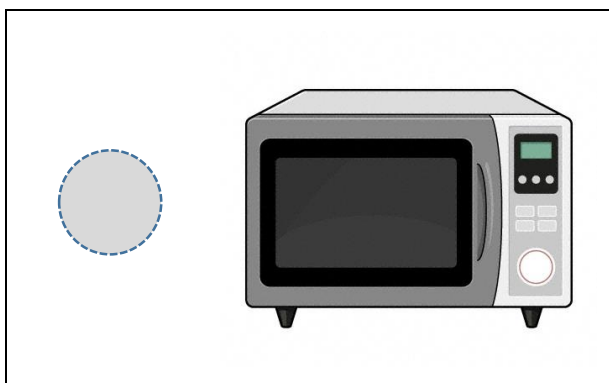
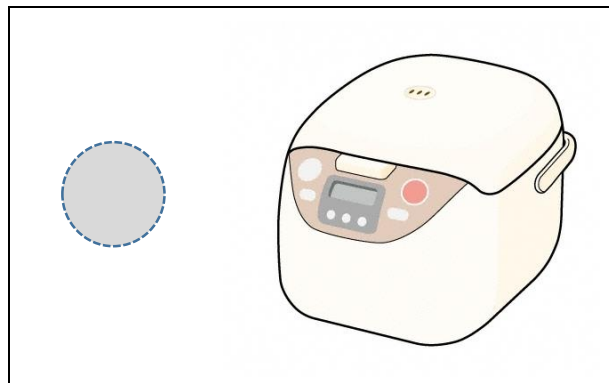
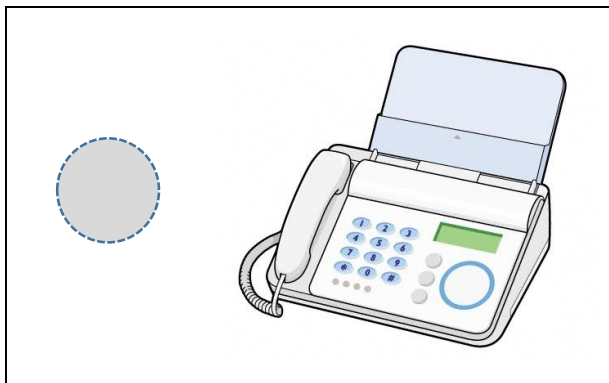

よくきいて ください。 \_\_\_\_\_ 月 \_\_\_\_\_ 日 \_\_\_\_\_ 曜日 名前 \_\_\_\_\_

☆. きこえた ことばのえに シールを はりましょう。

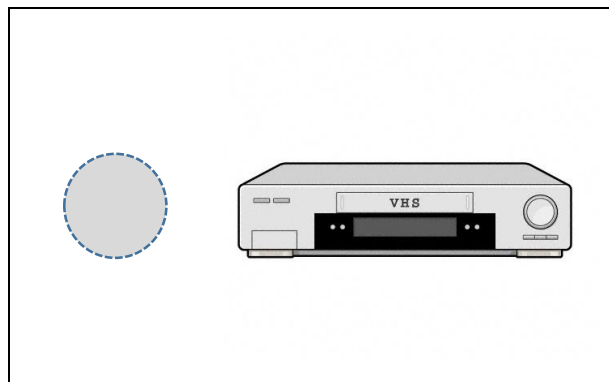
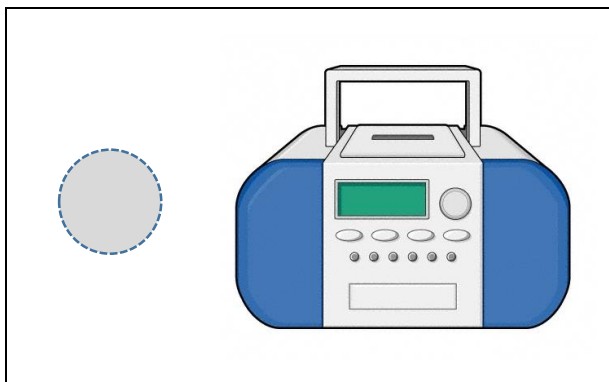
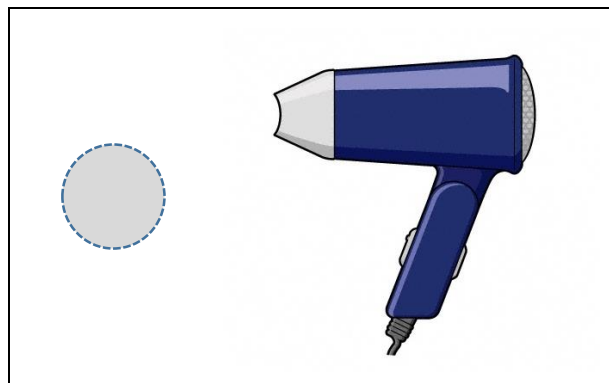
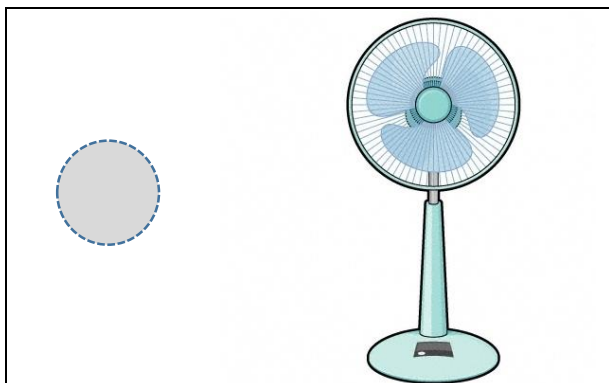
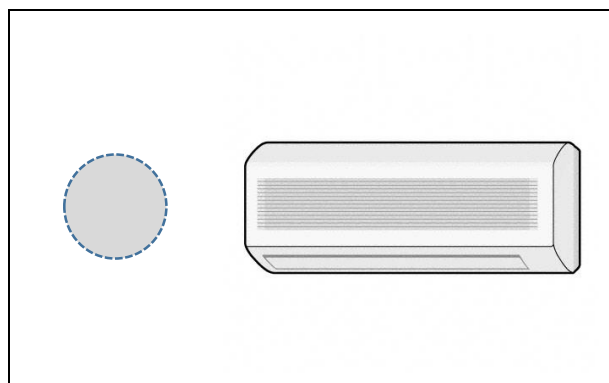
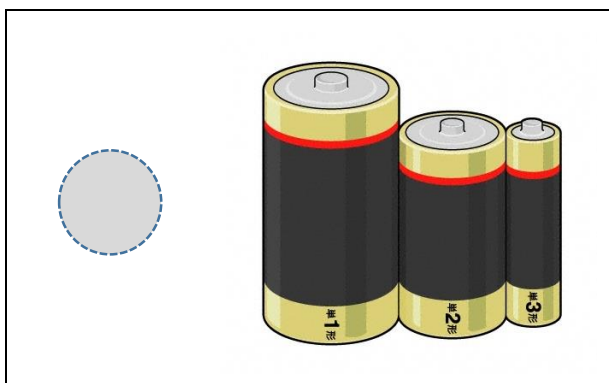
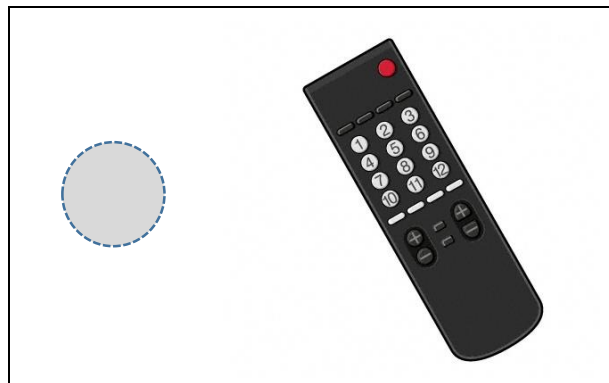
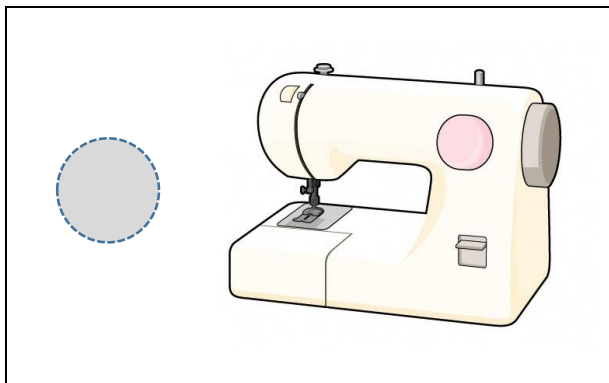

よくきいて 答えましょう。 \_\_\_\_\_ 月 \_\_\_\_\_ 日 \_\_\_\_\_ 曜日 名前 \_\_\_\_\_

☆. きこえた ことばのえに シールを はりましょう。

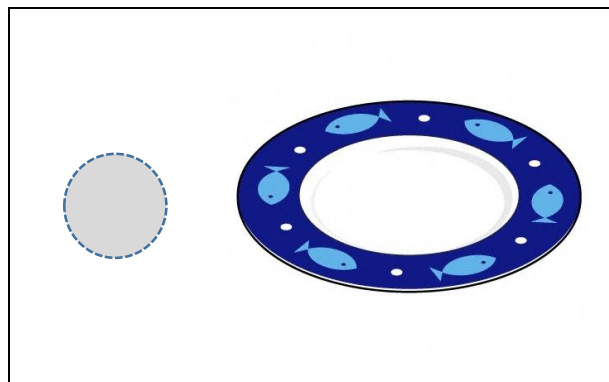
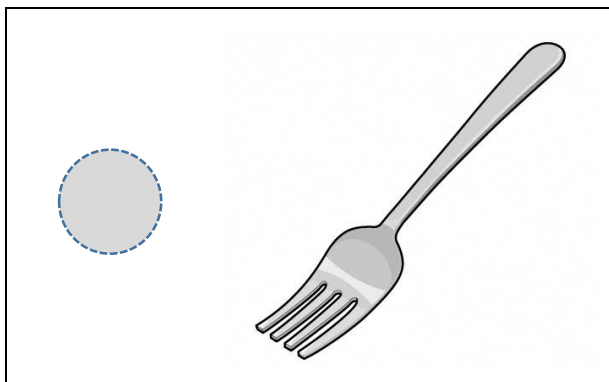
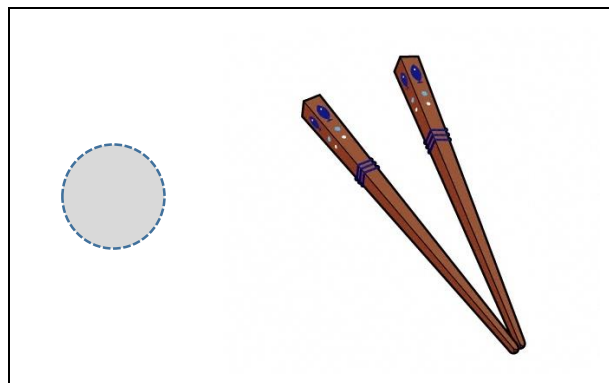
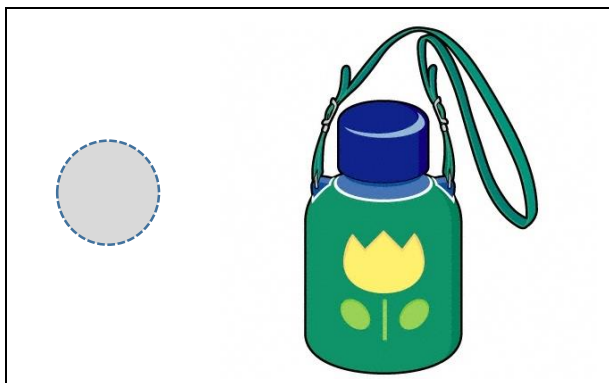
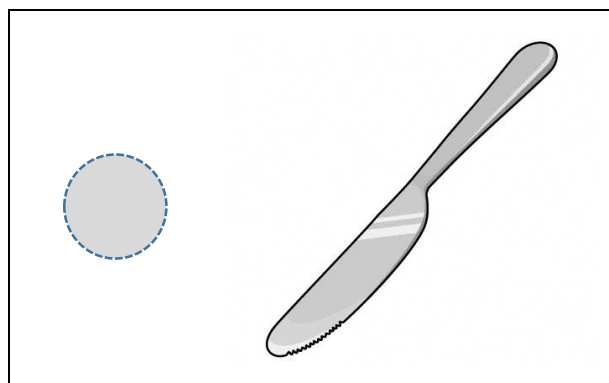
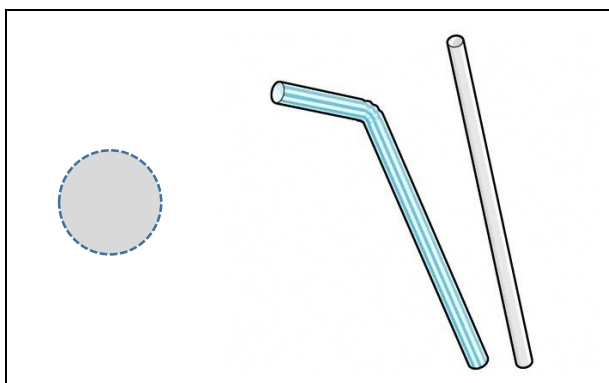
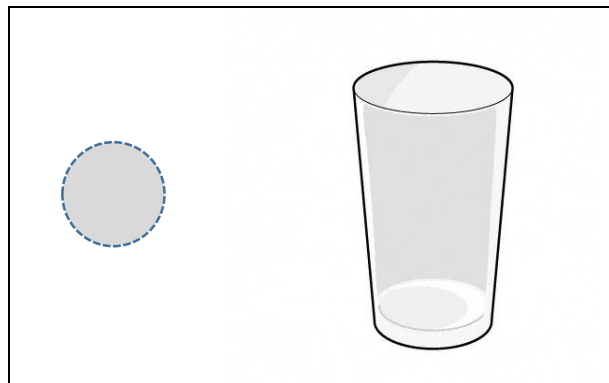
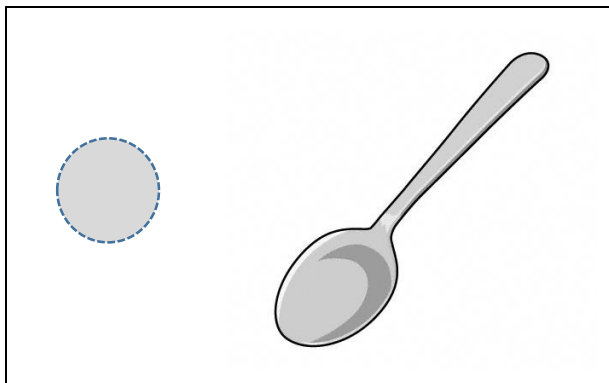

よくきいて ください。 \_\_\_\_\_ 月 \_\_\_\_\_ 日 \_\_\_\_\_ 曜日 名前 \_\_\_\_\_

☆. きこえた ことばのえに シールを はりましょう。

